

The Evidence IS the Conspiracy

The Mauser, the Carcano & the Lt. DAY Rifle

by David Josephs

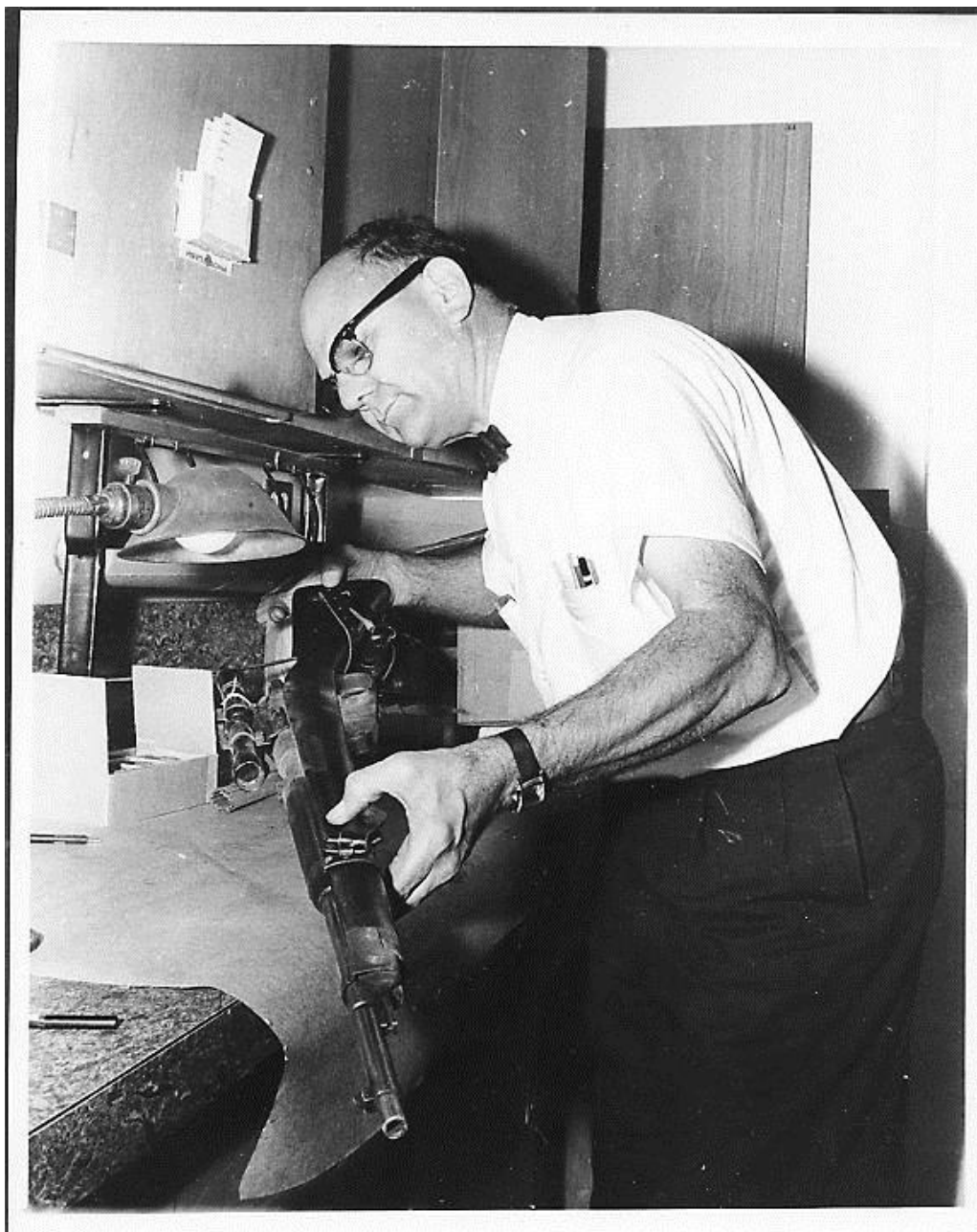

(Lt. Day examines the rifle – no clip in sight)

Table of Contents

The Mauser	3
The Carcano	8
Lt. DAY's Rifle	11
Conclusions	17
One More Thing	18
Appendix – Boone, Mooney, Hill, Craig & Weitzman	20



The clip (in WCR evidence) which was not seen or photographed inside the TSBD



yet is seen sticking out of the trigger guard as DAY is leaving the TSBD

The Mauser

Four veterans of the Dallas Police Department (DPD) & Sheriff Departments (DSO) are “claimed” to have seen a 7.65m Mauser – as written on the barrel – upon discovering a rifle hidden by boxes near the back stairs of the 6th floor.

No, that’s not right at all.

One of them, DPD Detective Roger **CRAIG** - a decorated officer, saw “7.65” and “MAUSER” stamped on the barrel both facing the same direction – an extremely specific identification.

Another of them, DPD Constable Seymour **WEITZMAN**, wrote an affidavit in his own hand that included the specific make and model of the weapon they saw. His affidavit states, “The rifle was a 7.65 Mauser bolt action” – not that it appeared to be, or might have been, but that it was a 7.65 Mauser.

Affidavits did not require such specific designation especially when Homicide’s Lt. DAY had in their presence declared the weapon a 6.5mm of Italian origin. Yet this 10-year veteran who worked for Captain **FRITZ** and on the same team as Crime Scene Investigator Lt. DAY did not take the generic course; he made a declarative statement.

A third, Deputy Sheriff E.L. **BOONE** from the County Sheriff’s Department, wrote his investigative and supplemental reports that same day and was just as specific. In fact, virtually identical language is used on both signed reports: “7.65 Mauser”, “Brownish black stock ... blue steel”, “1:22pm”.

I doubt anyone would have even noticed if Constable Seymour **WEITZMAN** or Deputy Sheriff E.L. **BOONE** or both just stated they had discovered a rifle, secured the area and waited for the Crime Scene Specialists to arrive led by Lt. DAY, with Robert Lee **STUDEBAKER** taking, as one would expect.

The 4th man in this circle is **DPD Captain FRITZ**, who was at the rifle site, and literally took the rifle and ejected the shell that was chambered and ready to be fired. With all the confusion revolving around this rifle it evidently was not common knowledge that the Carcano ejects its clip when the final bullet is loaded, not ejected like the M-1 Garand. FRITZ is said to have heard all this occurring yet denies this knowledge in testimony.

What follows is a **diagram of the clip system** of a Mannlicher (*showing how the clip is ejected when the last bullet is chambered, not ejected*) and the signed reports of BOONE and WEITZMAN.

FIG. 2: MANNLICHER CLIP SYSTEM © 1994 Richard Bartholomew

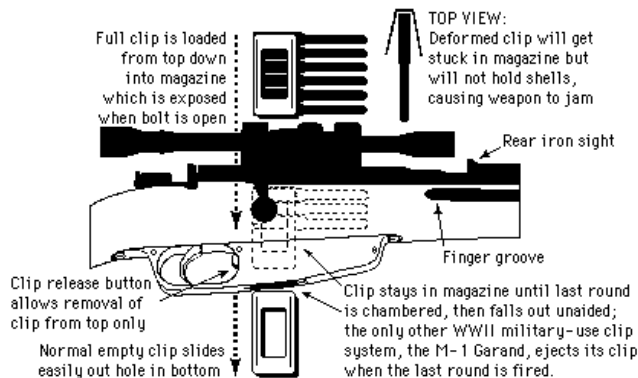

and ordered all of the sixth floor sealed off & searched. I was ~~being~~ working with Deputy S. Boone of the Sheriff & helping in the search. We were in the north west corner of the sixth floor when Deputy Boone & myself spotted the rifle about the same time. The rifle was a 7.65 Mauser bolt action equipped with a 4/13 scope. The rifle was found was 1:22 PM. The time the rifle was found was 1:22 PM. Notary Public, Dallas County, Texas

Date November 22 1963

After I had left the film in ID, I got a battery powered light and went over to the Texas School Book Depository to help with the search of building. I proceeded to the sixth (6th) floor of the building to search for the rifle. I started on the east end of the building and worked my way to the west end of the building. In the northwest corner of the building approx. three (3) feet from the east wall of the stairwell behind a row of cases of books I was the rifle, that appeared to be a 7.65mm Mauser

I recommend this case be declared	Unfounded	<input type="checkbox"/>	Case declared	Inactive (not cleared)	<input type="checkbox"/>
	Inactive (not cleared)	<input type="checkbox"/>		Unfounded	<input type="checkbox"/>
	Cleared by Arrest	<input type="checkbox"/>			

Signed _____ Investigating Officer Signed _____ Commanding Officer

DECKER EXHIBIT No. 5323—Continued

(Cont) Date _____ 19____ with a telescopic site. The rifle had what appeared to be a brownish, black stock and blue steel, metal parts. Capt. Fritz DPD was called to this location and along with an ID man DPD took charge of the rifle. Officer Whitman of Roble Loves office was with me when I found the rifle it was 1:22pm by my watch. I then returned to the station.

E. L. Boone
E. L. Boone #240 DSO

“After I had left the film in ID*” in Boone’s statement refers to:

- 1) after he ran to the Railroad parking yard and was “unable to locate anything”;
- 2) after he found Betzner;
- 3) after he brought him to the Sheriff’s office for a statement;
- 4) after they process his film, create negatives and print photos;
- 5) After they give Betzner back the camera and negatives; and
- 6) after Boone keeps 3 photos.

*see Full Report Appendix

In the cropped statement from his supplemental report above **BOONE** tries to make it sound as if he left the film and did not remain at the Sheriff’s office for all these other activities when in reality it appears as if the finding of the rifle waited around for **BOONE** to arrive. But that gets ahead of ourselves. The following graphic shows the Mauser stamp and “7.65” on the barrel facing the same direction with the Carcano sans scope above it. The name Roger **CRAIG** does not appear in either man’s signed account. It’s hard to fathom Lt. DAY identifying this rifle as 6.5mm & Made in Italy based on its “markings”, given how clear the “MAUSER” and “7.65” are...

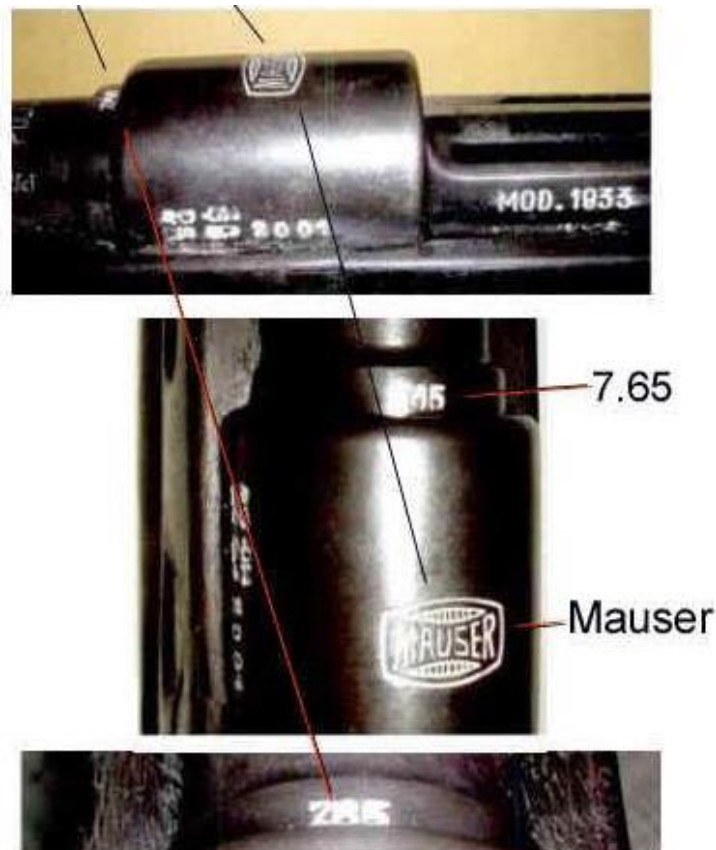



What Roger Craig Said

"...and stamped right on the barrel of the rifle was 7.65 Mauser. And that's when Weitzman said it is the Mauser and pointed to the 7.65 Mauser stamp on the barrel "

"After a *close* examination (much longer than Fritz or Day's examination) Weitzman declared that it was a 7.65 German Mauser. Fritz agreed with him."



Credit to:



SM © 8

Fritz agreed with



SM © 8

Is the source of this info. If you are or know this person – all credit due for finding what so many have strived to find. The Carcano with scope erased is at the top.

An example of the Argentine 7.65 Mauser with these markings has been extremely difficult to find. Sadly though, the placement of these markings creates yet another conflict. The two signed reports on the matter describe a scope attached to the Mauser. The way a scope is mounted on a Mauser, the exact spot where the MAUSER stamp resides is completely covered up.

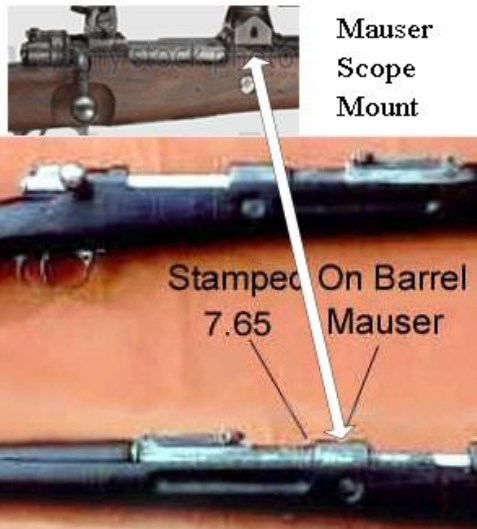

DETAILS OF OFFENSE, PROGRESS OF INVESTIGATION, ETC.
 (Investigating Officer must sign)
 Date Nov. 22, 1963

Mr. Decker:

I was assisting in the search of the 6th floor of the Dallas County Book Depository at Elm at and Houston St. proceeding from the Northwest East side of the building. Officer Whitman DPO and I were together as we approached the Northwest corner of the building ~~XXXXXXXXXX~~ I was the rifle partially hidden behind a row of books with two (2) other boxes of books against the rifle. The rifle appeared to be a 7.65mm Mauser with a telescope sight on the rifle. Capt. Fritz was called to the scene and also someone from the ID ~~XXXXXX~~ pictures were taken and then Capt Fritz picked up the rifle. I first saw the rifle at 1:22pm date.

E. L. Boone 240 DSO

While that appears to be a deal breaker – we have the following testimony from the man who, after he says he can't identify Oswald, claims he could identify Oswald but chose not to. Well, okay, yet if he was that sure about the man recessed in that window, can we take what he says about the rifle and the scope as an indication these men could have been correct? That they combined the description of TWO RIFLES IN THE TSBD into one? Wouldn't be the first time. It's hard to imagine Brennan did not see a scope given this testimony:

Mr. BELIN. Could you tell whether or not it had any kind of a scope on it?
 Mr. BRENNAN. I did not observe a scope.
 Mr. BELIN. Could you tell whether or not it had one?
 Do you know whether it did or not, or could you observe that it definitely did or definitely did not, or don't you know?
 Mr. BRENNAN. I do not know if it had a scope or not.

Mr. BELIN. How much of the gun do you believe that you saw?
 Mr. BRENNAN. I calculate 70 to 85 percent of the gun.

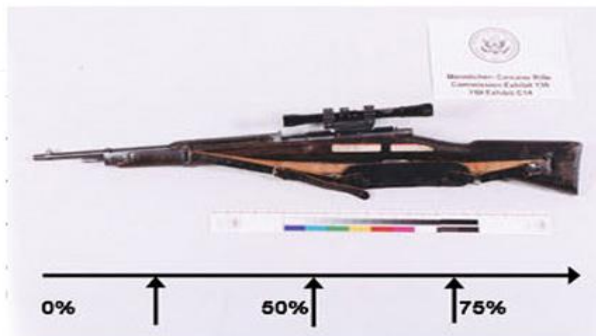

The Carcano

[CE139](#) is the official designation for the rifle supposedly found at 1:22 pm by the back stairs of the TSBD on the 6th floor.

[CE541](#) is a series of close up photos of the Carcano offered as evidence. By using a little contrast and brightness we can make out these markings: "CAL ??5" / "1940" / "Made Italy" / Crown design and letters. "CAL" appears just being the metal sight on the barrel with "1940" and "MADE ITALY" a little further down the barrel.

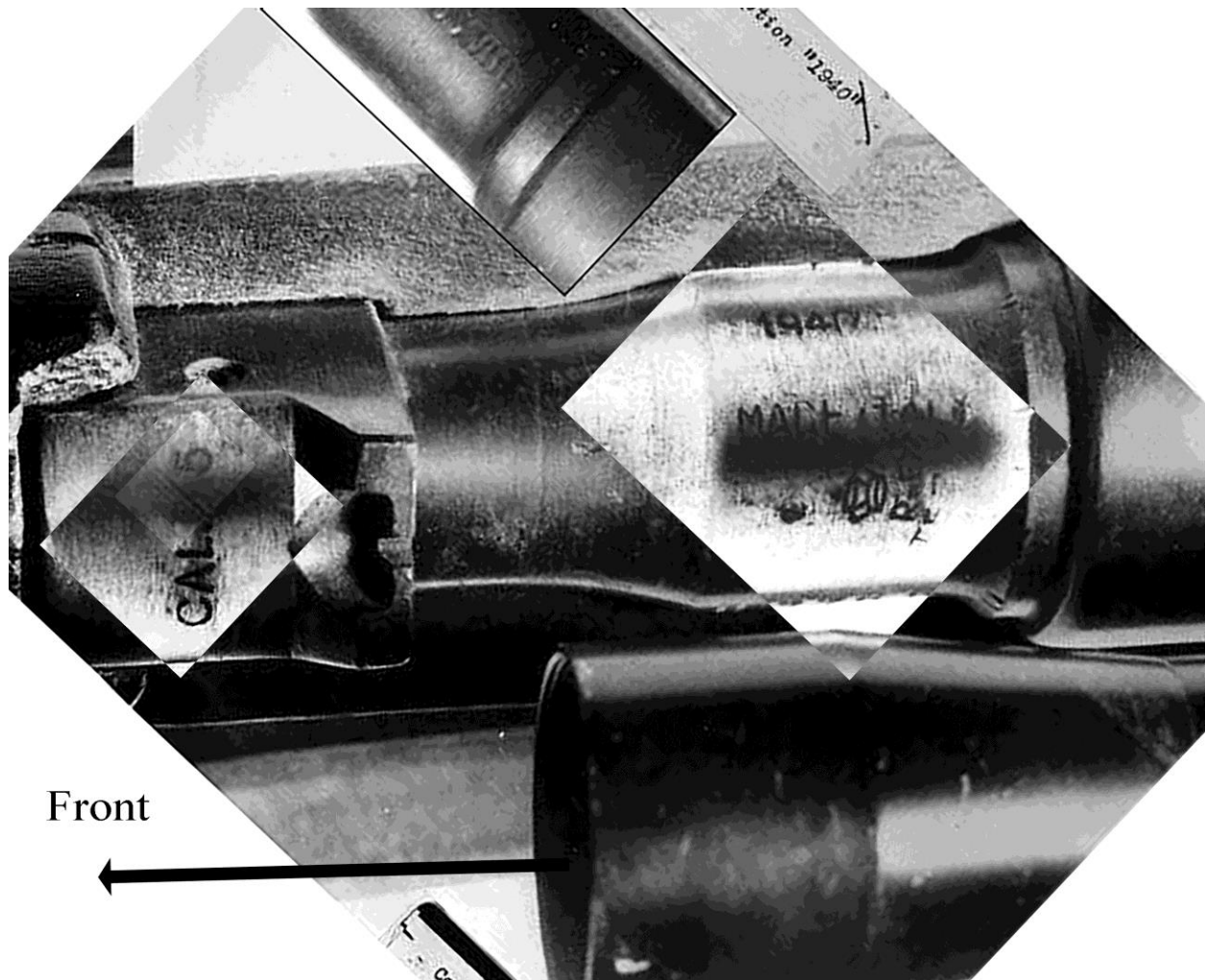

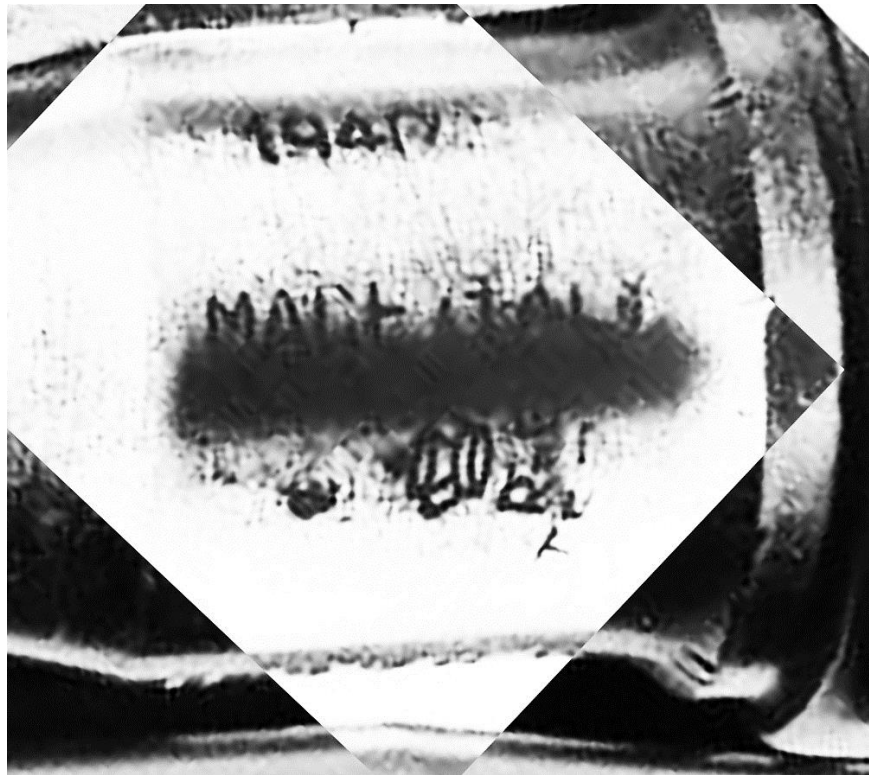

On the evening of November 22, 1963 at approximately 11:45pm, Special Agent Vincent **DRAIN** acquired a rifle from the Dallas Police Department along with what we know now was every single piece of evidence collected – and took it to FBI HQ and their Lab in Washington DC.

All other evidence collected by the Crime Scene Search was released at 11:45 P.M. November 22, 1963 to Agent Vince Drain to be delivered to the F.B.I. headquarters at Washington, D.C.

Respectfully submitted,

J. C. Day 391
Lieutenant of Police
Identification Bureau

But was the Carcano, the rifle that becomes CE139, the same rifle as the one we see **DAY** carrying as he leaves the TSBD?



Lt. DAY's Rifle

One man who entered the TSBD about the time **FRITZ** did was Newsman Thomas **ALYEA** who filmed the first moving images inside the TSBD's 6th floor. This is **FRITZ, WEITZMAN** and **CRAIG** by the area the rifle was found, as filmed by **ALYEA**.



ALYEA – <http://www.jfk-online.com/alysa.html>

*Shortly after we arrived back on the 6th floor, **Deputy Eugene Boone located the assassin's rifle** almost completely hidden by some overhanging boxes near the stairwell. I filmed it as it was found. In my shot, the figure of Captain Fritz is standing within the enclosure next to the rifle. He knew then that the possibility of a fire fight with the sniper had greatly diminished. He dispatched one of his men to go down and call for the crime lab. **About fifteen minutes later, Lt. Day and Studebaker arrived. Still pictures were taken of the positioning of the rifle, then Lt. Day slid it out from its hiding place and held it up for all of us to see.***

The world has seen my shot of this many times. Lt. Day immediately turned toward the window behind him and started dusting the weapon for fingerprints. Day was still within the enclosure formed by the surrounding boxes.



Except it looks in the film as if **DAY** turns the rifle from horizontal to vertical while the photos of the rifle show it vertical from the start.

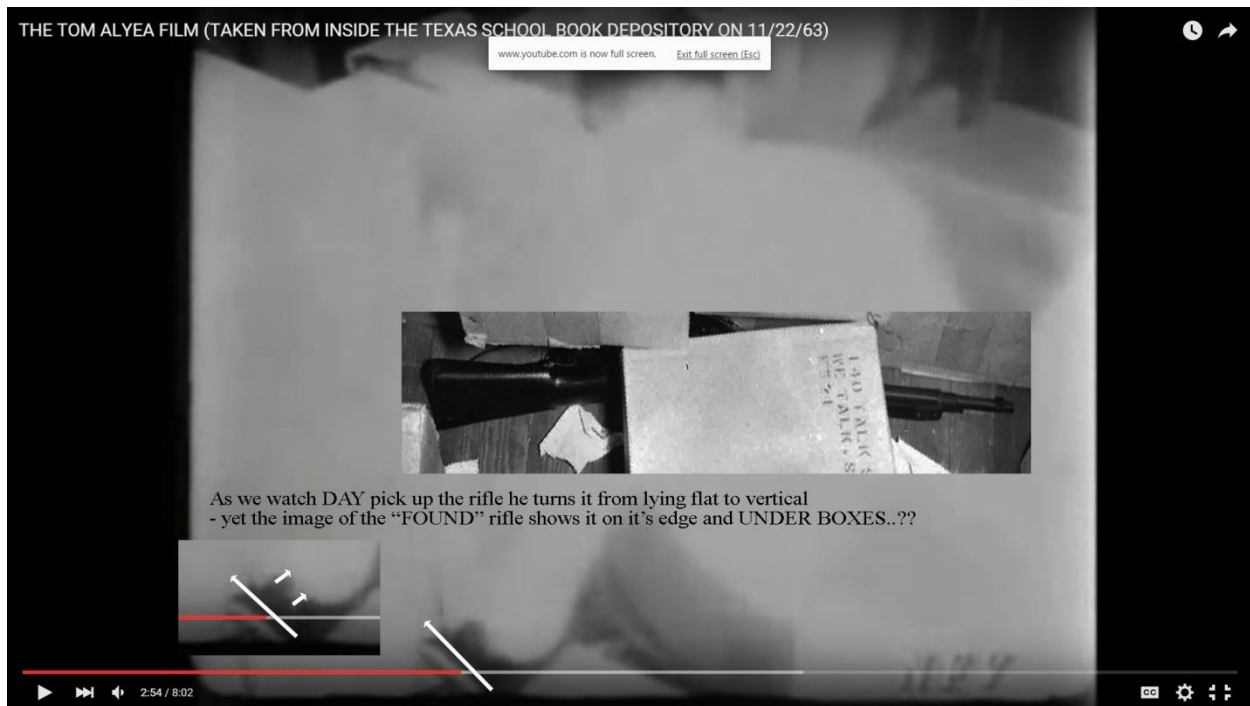

ALYEA continued:

I filmed him lifting prints from the rifle. He lifted them off with scotch tape and placed them on little white cards. When he had finished, he handed the rifle to Captain Fritz. Fritz pulled the bolt back and a live round ejected and landed on the boxes below. Fritz put the cartridge in his pocket. I did not see Fritz pick up anything other than the live round

So here we are ... a slew of Deputy Sheriffs along with Constables, traffic cops and Homicide Detectives have been in and out of the building – people have been coming and going for over 40 minutes when finally, someone spots a rifle.

At **1:22 pm** a rifle was finally found under some boxes on the 6th floor of the Texas School Book Depository. By *most* accounts of those seeing and hearing shots other than from the Railroad area, they came from the SE corner of the building on the NW corner of Elm and Houston.

An incredible 52 minutes after shots rang out according to the giant Hertz sign/clock atop the fated building. Fifty-two minutes that ended with at least 4 senior ranking and veteran law enforcement officers – one having owned a sporting goods store – stating for the record the rifle found was a 7.65 Mauser bolt action.

Lt. **DAY** leaves the TSBD with a rifle and gets back to his office around 2pm.

*Mr. BELIN. Did you **ever hear this rifle referred to as a 7.65 Mauser** or as any type of a Mauser?*

*Mr. DAY. **Yes, sir; it wasn't** referred to as that.*

Say again? Yes, it wasn't.

DAY goes on to say this non-occurring reference occurs **as he is leaving with the rifle when** newsmen outside ask whether it was a 30.06 or Mauser.

Mr. BELIN. Did you ever describe the rifle as anything but a 6.5-caliber with regard to the rifle itself?

*Mr. DAY. **I didn't describe the rifle to anyone other than police officers.***

DAY claims to have had his secretary type up notes

Mr. DAY. To my secretary. She wrote on the typewriter: "4 x 18, coated, Ordinance Optics, Inc., Hollywood, California, 010 Japan. OSC inside a cloverleaf design."

Mr. BELIN. What did that have reference to?

*Mr. DAY. That was stamped on the scopic sight on top of the gun. On the gun itself, "6.5 caliber C-2766, **1940 made in Italy.**" That was what was on the gun. I dictated certain other stuff, other information, for her to type for me.*

Mr. BELIN. Well, you might just as well dictate the rest there.

*Mr. DAY. "When bolt opened one live round was in the barrel. No prints are on the live round. Captain Fritz and Lieutenant Day opened the barrel. Captain Fritz has the live round. Three spent hulls were found under the window. They were picked up by Detective Sims and witnessed by Lieutenant Day and Studebaker. **The clip is stamped 'SMI, 9 x 2.'**"*

11-22-63

4 X 18 COATED ORDINANCE OPTICS INC. HOLLYWOOD, CALIFORNIA
 O10 JAPAN OSC INSIDE A CLOVERLEAF DESIGN
6.5 CALIBER C 2766

WHEN BOLT OPENED, ONE LIVE ROUND WAS IN THE BARRELL. NO PRINTS
 ARE ON THE LIVE ROUND. CAPT. FRITZ AND LT. DAY OPENED THE BARRELL.
 CAPT. FRITZ HAS THE LIVE ROUND. THREE SPENT HULLS WERE FOUND UNDER
 THE WINDOW. ^{STRAUBER} THEY WERE PICKED UP BY DET. SIMS AND WITNESSED BY
 LT. DAY. * THE CLIP IS STAMPED SMI 952.

1940
 Made in Italy

SM

Mr. McCLOY. There was never any doubt in your mind what the rifle was from the minute you saw it?

Mr. DAY. No, sir; It was **stamped right on there, 6.5**, and when en route to the office with Mr. Odum, the FBI agent who drove me in, he radioed it in, he radioed in what it was to the FBI over the air.

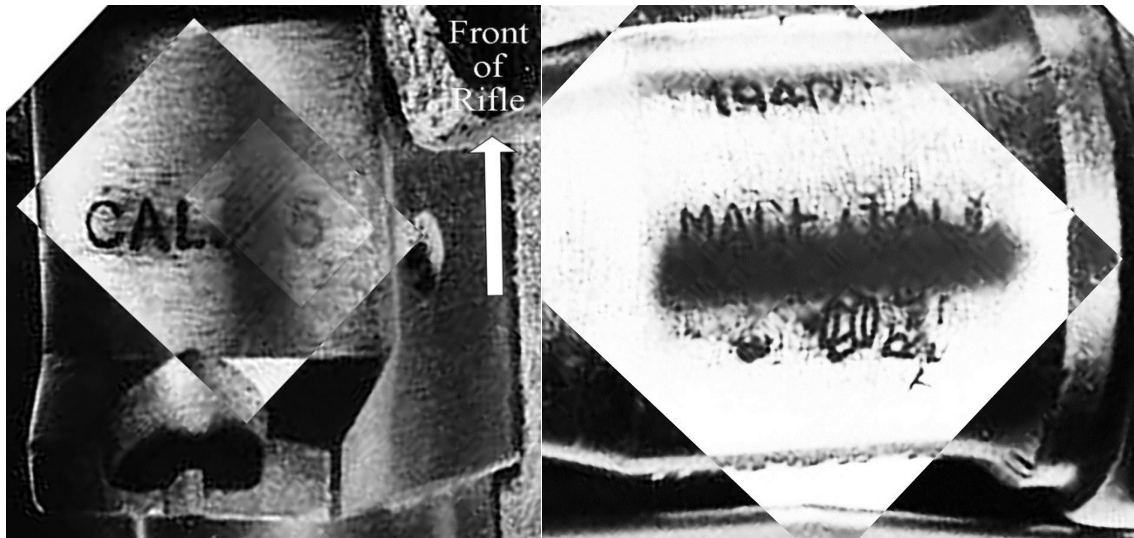



Giving this image even a close look, it appears very much like CE139, the rifle in evidence. But remember the Carcano markings? We would expect to see these same markings on this rifle as he leaves. Luckily this image is from the Texas Portal and is VERY large and clear.

1. There is no "CAL 6.5" on **DAY's** rifle;
2. There is no "Made Italy";
3. The scope looks different;
4. The flange behind Made Italy under the scope is not the same – CE139 has a pronounced ridge then the piece, DAY's appears much smoother and the distance from flange to sight is different.

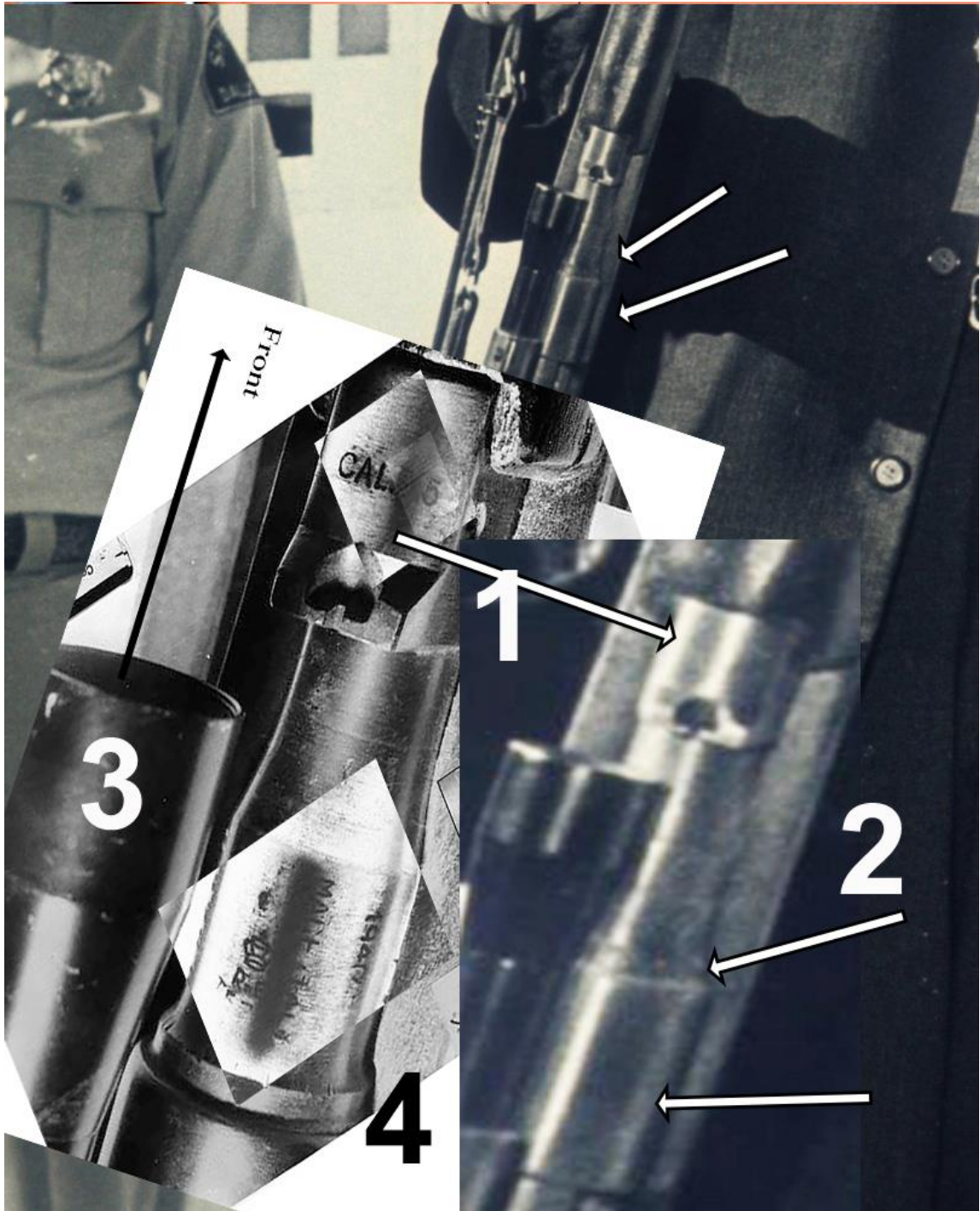

Conclusions

The Mauser with 7.65 stamped on its barrel exists and is very similar to the Carcano 40.2" Fucile Corto without a scope, except it loads completely differently, leaving no clip behind, and there is no trigger assembly for the clip that isn't there.



A Deputy Sheriff and Constable sign affidavits attesting to the make and caliber of the found rifle based on an obvious stamp which would be hidden by a mounted scope.

The rifle presented to the Warren Commission becoming CE139 has specific markings as represented by the Report's exhibit photographs.

When compared to the rifle in DAY's hand as he leaves the TSBD, it appears that those marking are not there and there are slight differences in the barrel.

I had originally thought of including the evidence for how easy it was for most anyone to leave evidence behind. How Oswald could have actually been in Dallas on Sept 28th at Sports Drome shooting and picking up shells, sighting in a scope. Or at least someone playing the part.

The community has proven beyond a shadow of a doubt that the rifle was never anywhere near Ruby's victim. What was said about it by the Dallas Police and Sheriff's department, the FBI and men referred to as Secret Service agents; as well as the Evidence which emerges days later after a trip to Washington, the death of the accused and back to Dallas, and back yet again to the FBI's Lab....

.... IS the Conspiracy.

One More Thing

Between the estimated times of 12:34 and 12:37pm on 11/22, Inspector **SAWYER** of the DPD and two DPD men take the front elevator to the “top”. In this case, this is the fourth floor.

Mr. BELIN. Then what did you do? You went inside the building, is that correct?

*Mr. SAWYER. We immediately went inside the building. I took--I believe **Sgt. Harkness** may have gone with me. I am not positive of that.*

Mr. BELIN. Was the elevator on the first floor when you got there, or did you have to wait for it to come down?

Mr. SAWYER. Best of my recollection, it was there.

Mr. BELIN. You got to the elevator, went up, looked around back there. How long did you spend up there at the top floor that the elevator took you to?

Mr. SAWYER. Just took a quick look around and made sure there was nobody hiding on that floor. I doubt if it took over a minute at the most.

Mr. BELIN. To go up and look around and come down?

Mr. SAWYER. To look around on the floor. How long it took to go up, it couldn't have been over 3 minutes at the most from the time we left, got up and back down.

Mr. BELIN. Then that would put it around no sooner than 12:37, if you heard the call at 12:34?

Mr. SAWYER. Yes, sir.

HARKNESS was not one of the two men with **SAWYER**. He went around to the back of the TSBD

*Mr. BELIN - When **you told Inspector Sawyer** that you had a witness that said the shot came from the building, up to that particular moment, had the front part of the building been sealed off yet?*

Mr. HARKNESS - Yes, sir.

*Mr. BELIN - **It had already been sealed off?***

Mr. HARKNESS - There was two officers with Inspector Sawyer at the front.

Mr. BELIN - Were they stopping people from going in and out?

Mr. HARKNESS - I don't know.

Mr. BELIN - You don't know?

*Mr. HARKNESS - No, sir; I don't know that, because **I didn't go up and talk to them.***

Mr. BELIN - Was anyone around in the back when you got there?

*Mr. HARKNESS - There were some Secret Service agents there. I didn't get them identified. **They told me they were Secret Service.***

"...[FBI Agent James] Hosty told the [House] Select Committee that at the time of the assassination 'Frank' Ellsworth...had indicated that he had been in the grassy knoll area and for some reason identified himself as a Secret Service Agent.' 8 Ellsworth, deposed by the Committee, denied Hosty's allegation. We know, however, that he was in the immediate area.9 Interestingly, he and seven other ATF agents were among the first law enforcement personnel of any description to reach the sixth floor of the TSBD. If Ellsworth was in the vicinity, it remains to be asked how Hosty knew about it. (Peter Dale Scott, "Deep Politics," pg. 274)

"In 1963, if you would have asked me if I was a Secret Service agent, I most likely would have answered yes-our roles overlapped that much." (Frank Ellsworth to author Gus Russo in 1994, "Live By The Sword," pg. 473)10

While I feel confident about Mr. Scott's work, Mr. Russo's I'm not as sure of. Yet it would make sense. ATF (at this time AT&TU) is another of those agencies from which little info related to JFK seems to be discussed or available.

Mr. **ELLSWORTH** claims that the rifle, the Carcano, was found on the fourth or fifth floor, not the same floor as the shells. Yet he remains the only one still stating this.

Add now the Mauser controversy, and what appears to be a similar yet different rifle in DAY's hands as he leaves the TSBD. Since **ODUM** of the FBI drove **DAY** to HQ and phoned in the make, model and serial number of the rifle, one wonders why it takes until 10 pm to track down Klein's, only to provide us with evidence which makes the rifle's journey that much more impossible.

The Evidence IS the Conspiracy IS the Evidence.....

Appendix – Boone, Mooney, Hill, Craig & Weitzman

This paper is about the evidence related to the rifle(s) described and photographed and what ultimately becomes CE139 – the 40” Fucile Corto rifle. While we do not have the time in this document to address all that occurred between 12:30 and 2 pm inside the TSBD, a subsequent paper will delve deeper into those 90 minutes.

This Appendix illustrates the conflicts between the Dallas Police Department and the Dallas Sheriff’s Office. It also corroborates some of the info which gets changed after the fact.

What strikes me as strange is that, despite the similarities between the **BOONE** and **WEITZMAN** statements, the timing of their statements appears to conflict.

Mr. BALL - Where did you view the parade?

*Mr. BOONE - **Right in front of the sheriff's office.** (Corner of Main & Houston)*

Mr. BALL - You turned to your right and went west?

*Mr. BOONE - Well, there is a big cement works out there. We went on **west across Houston Street, and then cut across the grass out there behind the large cement works there.** Some of the bystanders over there seemed to think the shots came from up over the railroad in the freight yards, from over the triple underpass.*

*So there was some city officer, I don't know who he was, motorcycle officer had laid his motorcycle down and was running up the embankment to get over a little retaining wall that separates the freight yards there. He went over the wall first, and I was right behind him, going into the freight yards. **We searched out the freight yards. We were unable to find anything.***

*Mr. BOONE - Well, I finally went around and was talking to some of the spectators that were in the area there, **located a boy by the name of Betzer(sic).** He had taken what he thought was some photographs, or there were photo-graphs--he thought he might have had a portion of the building.*

Later on we were able to ascertain that the shots had come from the building, from that southeast corner over there. And he had some photographs, but they didn't extend past the second floor on the building.

Mr. BALL - Did you go up into the building then?

*Mr. BOONE - **I took him on over to the sheriff's office, and placed him in the sheriff's office, took his camera, to bring it back to the ID Bureau to be developed.** Placed him in the sheriff's office at that time to await somebody to take a statement from him. Then some other officers, Ralph Walters and Officer Gramstaff, and I don't know*

whether--I don't remember Officer Mooney was with them or not at that time they headed back to get some heavy power flashlights. They said they wanted to look around in the attic. And there were a bunch of pallets, that they moved the books around, and it was dark and they couldn't see. So we got the lights and went over to the building. At that time, **we proceeded directly to the sixth floor.**

Mr. BALL - Somebody tell you to go to the sixth floor?

Mr. BOONE - **Well, that is just where everybody was going.** And they said five floors below that--I believe Inspector Sawyer with the city was out there, and he said the other floors were in the process of being searched or had been already searched. **This was after Officer Mooney found the shells.**

Except **ALYEA** corrected his statement

I do however know that Officer Mooney was present when the rifle was found because I took film of him at the scene.

with the following:

(Important correction) Take out the sentence that starts with : " I do however know that Officer Mooney..."

*Mooney was a Sheriff's Deputy, not a police officer. He **did not arrive on the sixth floor** until after the rifle was found and the search was over.*

[Luke Mooney WC Testimony](#)

*I started running across Houston Street and down across the lawn to the triple underpass and up the terrace to the railroad yards. I searched along with many other officers, this area, **when Sheriff Bill Decker came up and told me and the Officers Sam Webster and Billy Joe Victory to surround the Texas School Book Depository building.***

I was the only person on the 6th floor when I searched it and was reasonably sure that there was no one else on this floor as I searched .

*Inside this cubby hole affair was three more boxes so arranged as to provide what appeared to be a rest for a rifle. **On one of these cartons was a half-eaten piece of chicken.** The minute that I saw the expended shells on the floor, I hung my head out of the half opened window and signaled to Sheriff Bill Decker and Captain Will Fritz who were outside the building and advised them to send up the Crime Lab Officers at once that I had located the area from which the shots had been fired. At this time, Officers Webstr, Victory, and McCurley came over to this spot and we guarded this spot until*

Crime Lab Officers got upstairs within a matter of a few minutes. We then turned this area over to Captain Fritz and his officers for processing.

*At this time I continued to search this 6th floor along with many other officers and within a few minutes, **I heard Deputy Sheriff Eugene Boone holler out that he had found the rifle** near the staircase between some rows of cartons.*

We continued to search the building for a suspect.

Bill **DECKER** was in the Lead Car that went to Parkland. Bill **DECKER** and Will **FRITZ** arrived back at the TSBD around 1pm – 30 minutes after the shooting. The only open window by the Sniper's nest was the Eastern-most window from where the shots supposedly had come. The windows where "someone" moved this bag of chicken & soda bottle, one set to the West, were both closed. **MOONEY** basically corroborates that this smaller bag HAD to have been moved by the time **DAY/STUDEBAKER** arrive to take photos.

Mooney:

I went straight across to the southeast corner of the building, and I saw all these high boxes. Of course they were stacked all the way around over there. And I squeezed between two. And the minute I squeezed between these two stacks of boxes, I had to turn myself sideways to get in there that is when I saw the expended shells and the boxes that were stacked up looked to be a rest for the weapon. And, also, there was a slight crease in the top box. Whether the recoil made the crease or it was placed there before the shots were fired, I don't know. But, anyway, there was a very slight crease in the box, where the rifle could have lain--at the same angle that the shots were fired from. So, at that time, I didn't lay my hands on anything, because I wanted to save every evidence we could for fingerprints. So I leaned out the window, the same window from which the shots were fired, looked down, and I saw Sheriff Bill Decker and Captain Will Fritz standing right on the ground.

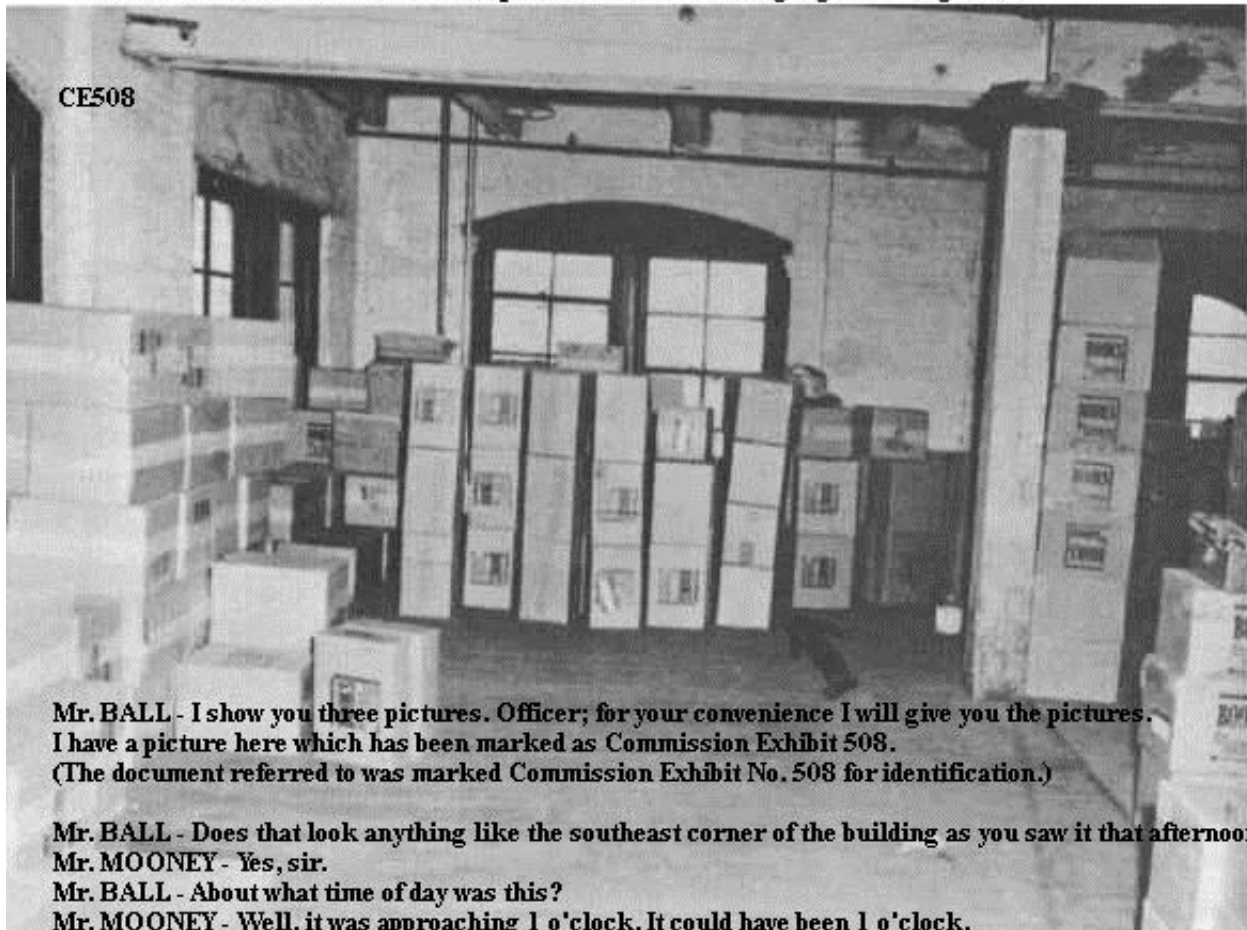

Now what about **MOONEY**'s claim he was alone on the 6th floor when he found the shells and hung his head out of the Shooter's window (half-open). Except Sergeant **GERALD HILL** tells a much different story:

Mr. BELIN. Then what did you do?

Mr. HILL. Left the uniformed officer there, and these two deputies and I went down to sixth. I started to the right side of the building.

Mr. BELIN. When you say the right side, you mean---

Mr. HILL. Well, it would have been the west side.

Mr. BELIN. All right, **they moved** over to the east side?

Mr. HILL. We hadn't been there but a minute until **someone yelled, "Here it is,"** or words to that effect.

On top of the larger stack of boxes that would have been used for concealmen(sic), **there was a chicken leg bone and a paper sack which appeared to have been about the size normally used for a lunch sack.** I wouldn't know what the sizes were. It was a sack, I would say extended, it would probably be 12 inches high, 10 inches long, and about 4 inches thick.

Then, on the floor **near the baseboard or against the baseboard of the south wall of the building, in front of the second window,** in front of the, well, we would have to say second window from the east corner, **were three spent shells.**

This is actually the jacket that holds the powder and not the slug. At this point, **I asked the deputy sheriff** to guard the scene, not to let anybody touch anything, and I went over still further west to another window about the middle of the building on the south side and yelled down to the street for them to send us the crime lab.

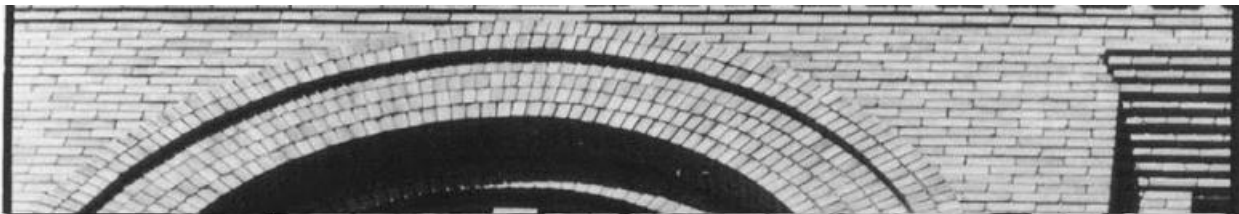

Shortly after 1:00 p.m., Dallas Police Sgt. Gerry Hill leans out of a sixth floor window, pointing to the corner window where an apparent sniper location and spent shell casings had been found moments earlier.



Another key story teller in this tale is Roger **CRAIG**.

Mr. CRAIG - So, we went to the sixth floor where--uh--some empty cartridges were found.

Mr. BELIN - Did you see the empty cartridges when they were found?

Mr. CRAIG - I didn't see them when they were found. I saw them laying on the floor.

Mr. BELIN - About how soon after they were found did you see them, laying on the floor?

Mr. CRAIG - Oh, a couple of minutes. I went right on over there. I was at the far north end of the building. The cartridges were on the southeast corner.

Mr. BELIN - Well, how did you know they had been found there? Did someone yell---or what?

Mr. CRAIG - Yes; someone yelled across the room that "here's the shells."

Mr. CRAIG - **I went over there** and--uh--didn't get too close because the shells were laying on the ground and there was--uh--oh, **a sack and a bunch of things laying over there**. So, you know, not to bother the area, I just went back across.

Mr. BELIN - Now, you say there was **a sack laying there?**

Mr. CRAIG - Yes; **I believe it was laying on top of a box**, if I'm not mistaken.

Mr. BELIN - How big a sack was that?

Mr. CRAIG - It was a paper bag (indicating with hands)--a small paper bag.

Mr. BELIN - Well, **the kind-of paper bag that you carry your lunch in?**

Mr. CRAIG - Yeah,--uh-huh.

This first set of men all concur – the lunch sack was in the corner, the shells where by the window and there was only one way in or out of the “sniper’s” area. That these shells were all within a small area over by the 2nd window, one west of the alleged sniper’s window.

Since we understand that Oswald was not on the 6th floor at this time, nor did he ever have C2766 in his possession – the rifle(s) found in the TSBD had to have been brought there by others. The shells, one of which was kept by the DPD and not turned over to the FBI had a bent lip, also had to have been planted.

From 12:30 until just after 1pm, the only men in the TSBD appear to be Sheriff’s Deputies and members of what would become ATF including one Frank ELLSWORTH. MOONEY, a Sheriff Deputy himself, claims not to recognize men from his own office. ATF agents also dressed in plainclothes.

*Mr. MOONEY - It was a push button affair the best I can remember. got hold of the controls and it worked. **We started up and got to the second. I was going to let them off and go on up. And when we got there, the power undoubtedly cut off, because we had no more power on the elevator.** So I looked around their office there, just a short second or two, and then **I went up the staircase myself. And I met some other officers coming down, plainclothes, and I believe they were deputy sheriffs. They were coming down the staircase.** But I kept going up. And how come I get off the sixth floor, I don't know yet. But, **anyway, I stopped on six, and didn't even know what floor I was on.***

Mr. BALL - You were alone?

Mr. MOONEY - I was alone at that time.

In the 30 minutes between 12:35 and 1:05, the TSBD was completely open to the comings and goings of anyone who desired.

In the 3 days that followed, evidence was produced from the “scene of the crime” which supported the conclusion that Oswald had

1. Brought a rifle to the TSBD
2. in a large paper bag
3. hidden the rifle so as not to be seen
4. built an enclosure to hide himself while workers laid flooring on the 6th
5. knew that JFK was running late
6. reacquired the rifle with enough time to
7. get back to the safety of his enclosure
8. reassembled the rifle and scope
9. loaded the partially filled clip into the Carcano
10. stayed quiet enough that Bonnie WILLIAMS hears nothing
11. accomplished the deadly shooting with amazing accuracy and skill
12. and escaped while leaving barely a trace of himself other than a mail order rifle, ordered in his supposed alias, in his supposed handwriting, from the Post Office he kept a PO Box and for which there is no evidence of ever having been delivered or claimed.

This “Evidence IS the Conspiracy” series of articles continues to juxtapose the evidence we are left with which to solve the crime and/or support the WCR findings – and the reality which underlies it all.

Thank you for taking this journey with me. If there are any questions you’d like to ask or topics you’d like to see covered, please email me at dhjosephs101@icloud.com .

DJ

COUNTY OF DALLAS
SHERIFF'S DEPARTMENT
SUPPLEMENTARY INVESTIGATION REPORT

Name of Complainant

Serial No.

Offense

Presidential Assassination

DETAILS OF OFFENSE, PROCESS OF INVESTIGATION, ETC.:
(Investigating Officer must sign)

Date November 22 1963

Mr. Decker:

At approx. 1pm date I was in front of the Sheriff's Office at 505 Main St Dallas Texas when I heard three shots coming from the vicinity of where the President's car was, I raced across the street (Main & Houston). The Presidential car and other cars were turning onto Stemmons Fwy. Some of the bystanders said the shots came from the overpass. I ran across the street (Elm) and up the embankment over the retaining wall and into the freight yard and was unable to locate anything. I located one (1) witness H. W. Betzner w/m 5922 Velasco Dr. phone TA-1-9761. He had taken some photos just prior to the shots (35mm film) Betzner was taken by me to the Sheriff's office for a statement. I took the camera and film to ID and had the film developed. Betzner had three (3) pictures just seconds prior to the rifle shots. The camera and negatives were returned to Betzner. The three (3) pictures were retained by me. Officer Homer Reynolds DPD obtained a statement from Betzner. The glossy prints of the pictures were turned over to Officer Reynolds to be placed with Betzner's statement.

After I had left the film in ID, I got a battery powered light and went over to the Texas School Book Depository to help with the search of building. I proceeded to the sixth (6th) floor of the building to search for the rifle. I started on the east end of the building and worked my way to the west end of the building. In the northwest corner of the building approx. three (3) feet from the east wall of the stairwell behind a row of cases of books I was the rifle, that appeared to be a 7.65mm Mauser

DETAILS OF OFFENSE, PROCESS OF INVESTIGATION, ETC.:
(Investigating Officer must sign)

(Cont)

Date 19

with a telescopic site. The rifle had what appeared to be a brownish, black stock and blue steel, metal parts. Capt. Fritz DPD was called to this location and along with an ID man, DPD took charge of the rifle. Officer Whitman* of Robie Loves office was with me when I found the rifle it was 1:22pm by my watch. I then returned to the station.

(Officer Whitman is actually
Constable Weitzman)

E. L. Boone #240 DSO

Mr. BALL - That's where Elm actually dead ends?
 Mr. WEITZMAN - Yes, sir; I scaled the wall and, apparently, my hands grabbed steampipes. I burned them.
 Mr. BALL - Did you go into the railroad yards?
 Mr. WEITZMAN - Yes, sir.
 Mr. BALL - What did you notice in the railroad yards?
 Mr. WEITZMAN - We noticed numerous kinds of footprints that did not make sense because they were going different directions.
 Mr. BALL - Were there other people there besides you?
 Mr. WEITZMAN - Yes, sir; other officers, Secret Service as well,

THE STATE OF TEXAS
 COUNTY OF DALLAS

AFFIDAVIT IN ANY FACT

BEFORE ME, _____

a Notary Public in and for said County, State of Texas, on this day personally appeared Seigman

Weitzman w/m / 2802 Estes Dr. - DPT-6624

Who, after being by me duly sworn, on oath deposes and says: Det. Robin Love RIF-1483

Yesterday Nov. 22, 1963. I was standing on the corner of Main & Hanston, & as the President passed & made his turn going west towards Stemmons, I walked casually around. At this time my partner was behind me & ask me something. I looked back at him & heard 3 shots. I ran in a north-west direction & scaled a fence towards where we thought the shots came from. Then someone said they thought the shots came from the old Texas Bldg. I immediately ran to this building & started looking inside. At this time Capt. Fritz arrived and ordered all of the sixth floor sealed off & searched. I was ~~working~~ ^{with} working ^{with} Deputy D. Boone of the Sheriff & helping in the search. We were in the north west corner of the sixth floor when Deputy Boone & myself spotted the rifle about the same time. The rifle was a 7.65

SUBSCRIBED AND SWORN TO BEFORE ME THIS _____ DAY OF _____ A.D. 196

Mausser bolt action equipped with a 4/18 scope ^{thick} leather brownish/black leather sling on it. ^{scope was attached} The time the rifle was found was 1:22 PM. Capt. Fritz took charge of the rifle & 1 live round from the chamber. I then went back to the office after this.